

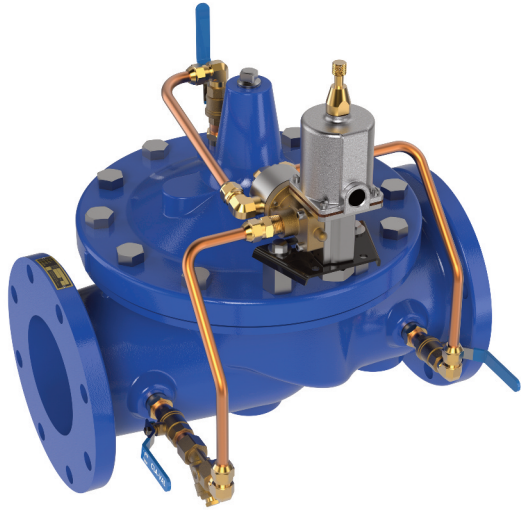

MODEL — **60-BY**

Booster Pump Control Valve with High Capacity Solenoid Control



- Simple Hydraulic Operation
- Low Head Loss
- Built-in Check Valve
- Proven Reliable Design

The Cla-Val Model 60-BY Booster Pump Control valve is a pilot-operated valve designed for installation on the discharge of booster pumps to eliminate pipeline surges caused by the starting and stopping of the pump.

The pump starts against a closed valve. When the pump is started, the solenoid control is energized and the valve begins to open slowly, gradually increasing line pressure to full pumping head. When the pump is signaled to shut-off, the solenoid control is de-energized and the valve begins to close slowly, gradually reducing flow while the pump continues to run. When the valve is closed, a limit switch assembly, which serves as an electrical interlock between the valve and the pump, releases the pump starter and the pump stops.

The Model 60-BY is an automatic valve of a modified globe-type design with a built-in, lift type, check feature. It is hydraulically operated and diaphragm-actuated. The CSM11-HC solenoid valve controls the valve operation.

Schematic Diagram

Item	Description
1	Hycheck Main Valve 100-04
2	CSM11-HC Solenoid Control
3	X105LCW Switch Assembly
4	CDC Check Valve
5	CDC/CSC Check valve
6	CK2 Isolation Valve
7	CNA Needle Valve

Optional Features

Item	Description
A	X46A Flow Clean Strainer
B	CK2 Isolation Valve
P	X141 Pressure Gauge
Y	X43 "Y" Strainer

Note: For main valve option descriptions, refer to the 100-04 Engineering Data Sheet.

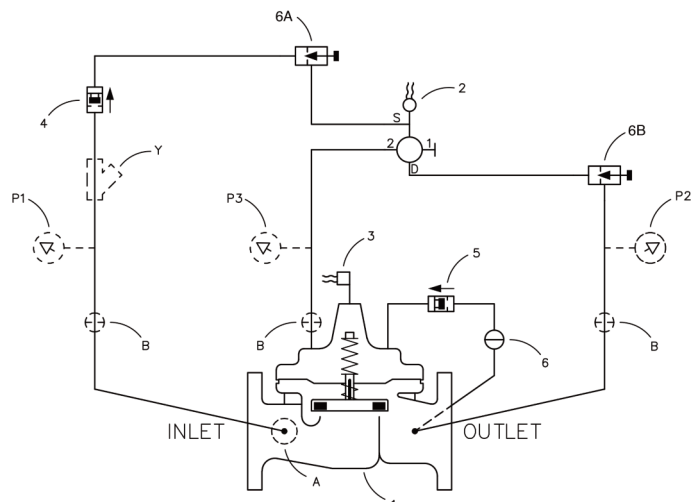

Typical Application

Install Model 60-BY valve as shown in multiple pump applications. Flexible conduit should be used for electrical connections to the solenoid control and the limit switch. A Model 52-03/652-03 Surge Anticipator Valve is recommended for power failure protection.

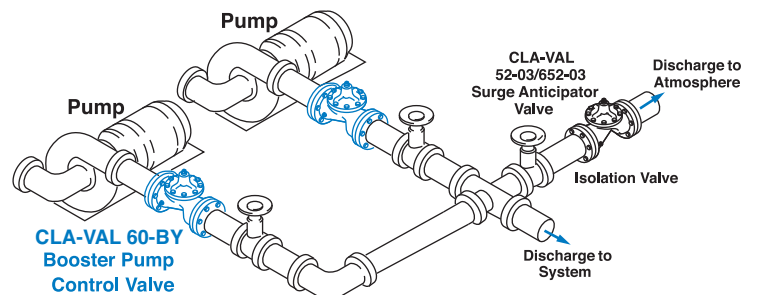

Pressure Ratings (Recommended Maximum Pressure - psi)

Valve Body & Cover		Pressure Class		
		Flanged		
Grade	Material	ANSI Standards*	150 Class	300 Class
ASTM A536	Ductile Iron	B16.42	250	400
ASTM A216-WCB	Cast Steel	B16.5	285	400
UNS 87850	Bronze	B16.24	225	400

Note: * ANSI standards are for flange dimensions only.
Flanged valves are available faced but not drilled.

Materials

Component	Standard Material Combinations		
Body & Cover	Ductile Iron	Cast Steel	Bronze
100-04 Inches	6" - 16"	6" - 16"	6" - 16"
100-04 Metric	150 - 400 mm	150 - 400 mm	150 - 400 mm
Disc Retainer & Diaphragm Washer	Cast Iron	Cast Steel	Bronze
Trim: Disc Guide, Seat & Cover Bearing	Bronze is Standard Stainless Steel is Optional		
Disc	Buna-N® Rubber		
Diaphragm	Nylon Reinforced Buna-N® Rubber		
Stem, Nut & Spring	Stainless Steel		

For material options not listed, consult factory.
Cla-Val manufactures valves in more than 50 different alloys.

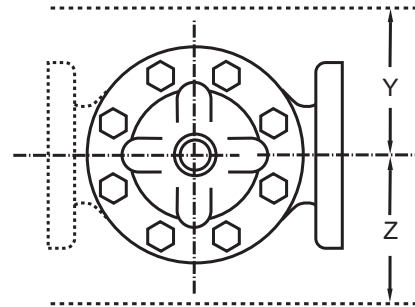
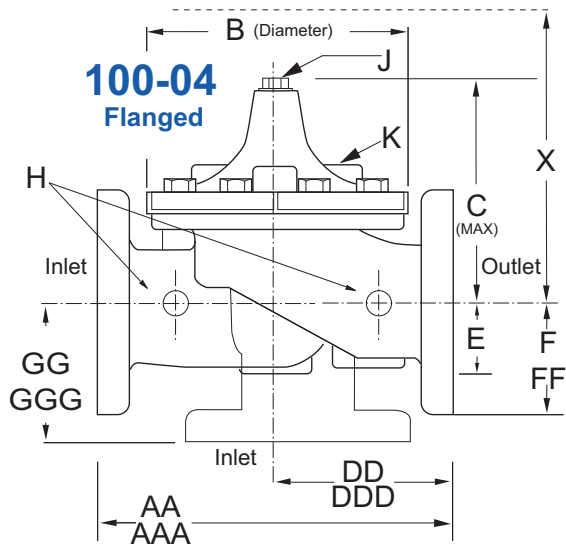

60-BY Series Dimensions (Uses HyCheck Main Valve 100-04) (inches)

Valve Size (Inches)	6	8	10	12	14	16
A 150 ANSI	20.00	25.38	29.75	34.00	39.00	41.38
AA 300 ANSI	21.00	26.38	31.12	35.50	40.50	43.50
B Diameter	15.75	20.00	23.62	28.00	32.75	35.50
C Maximum	13.38	16.00	17.12	20.88	24.19	25.00
D 150 ANSI	10.00	12.69	14.88	17.00	19.50	20.69
DD 300 ANSI	10.50	13.19	15.56	17.75	20.25	21.75
E	4.31	5.31	9.25	10.75	12.62	15.50
F 150 ANSI	5.50	6.75	8.00	9.50	10.50	11.75
FF 300 ANSI	6.25	7.50	8.75	10.25	11.50	12.75
G 150 ANSI	6.00	8.00	8.62	13.75	14.88	15.69
GG 300 ANSI	6.50	8.50	9.31	14.50	15.62	16.50
H NPT Body Tapping	0.75	1.00	1.00	1.00	1.00	1.00
J NPT Cover Center Plug	0.75	1.00	1.00	1.25	1.50	2.00
K NPT Cover Tapping	0.75	1.00	1.00	1.00	1.00	1.00
Stem Travel	1.70	2.30	2.80	3.40	4.00	4.50
Approx. Ship Weight (lbs)	285	500	780	1165	1500	2265
Approx. X Pilot System	29.00	31.00	33.00	36.00	40.00	40.00
Approx. Y Pilot System	20.00	22.00	24.00	26.00	29.00	30.00
Approx. Z Pilot System	20.00	22.00	24.00	26.00	29.00	30.00

60-BY Series Metric Dimensions (Uses Hycheck Main Valve 100-04) (mm)

Valve Size (mm)	150	200	250	300	350	400
A 150 ANSI	508	645	756	864	991	1051
AA 300 ANSI	533	670	790	902	1029	1105
B Diameter	400	508	600	711	832	902
C Maximum	340	406	435	530	614	635
D 150 ANSI	254	322	378	432	495	526
DD 300 ANSI	267	335	395	451	514	552
E	109	135	235	273	321	394
F 150 ANSI	140	171	203	241	267	298
FF 300 ANSI	159	191	222	260	292	324
G 150 ANSI	152	203	219	349	378	399
GG 300 ANSI	165	216	236	368	397	419
H NPT Body Tapping	0.75	1.00	1.00	1.00	1.00	1.00
J NPT Cover Center Plug	0.75	1.00	1.00	1.25	1.50	2.00
K NPT Cover Tapping	0.75	1.00	1.00	1.00	1.00	1.00
Stem Travel	43	58	71	86	102	114
Approx. Ship Weight (kgs)	129	227	354	528	726	1027
Approx. X Pilot System	737	787	838	914	1016	1016
Approx. Y Pilot System	508	559	610	660	737	762
Approx. Z Pilot System	508	559	610	660	737	762

Model 60-BY Flow Chart (Uses Main Valve Model 100-04)

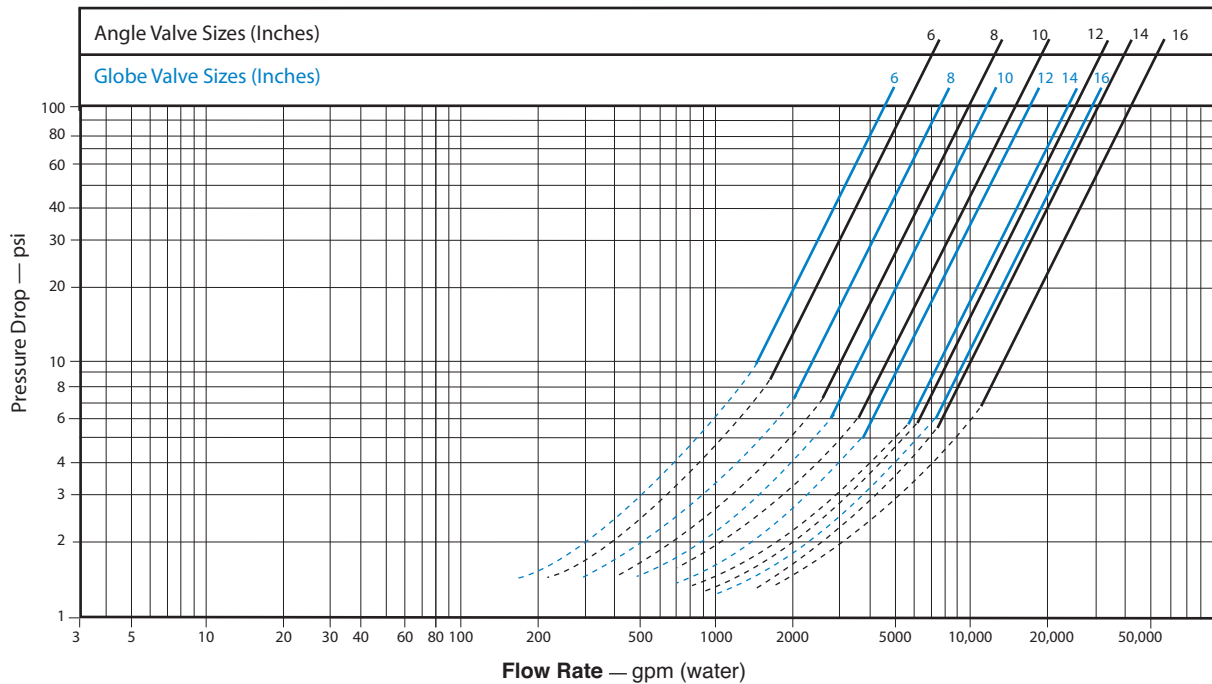

Cover Capacity

Liquid Volume Displaced from Diaphragm Chamber When Valve Opens or Closes

Valve Size	Displacement
6"	.531 gal
8"	1.26 gal
10"	2.51 gal
12"	4.00 gal
14"	6.50 gal
16"	9.57 gal

When Ordering, Please Specify:

1. Catalog No. 60-BY
2. Valve Size
3. Pattern - Globe or Angle
4. Pressure Class (Flanged)
5. Trim Material
6. Electrical Selection
7. Desired Options
8. When Vertically Installed (Flow Direction)

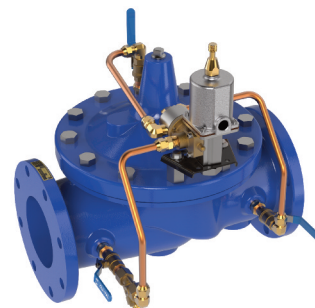

60-BY Valve Selection	100-04 Pattern: Globe (G), Angle (A), End Connections: Threaded (T), Flanged (F) Indicate Available Sizes						
	Inches	6	8	10	12	14	16
	mm	150	200	250	300	350	400
Main Valve 100-04	Pattern	G, A	G, A	G, A	G, A	G, A	G, A
	End Detail	T, F	T, F	F	F	F	F
Suggested Flow (gpm)	Maximum	1800	3100	4900	7000	8400	11000
	Maximum Intermittent	2250	3900	6150	8720	10540	13700
Suggested Flow (Liters/Sec)	Maximum	113	195	309	442	530	694
	Maximum Intermittent	142	246	387	549	664	863

100-04 Series is the full internal port Hycheck.

CSM11-HC Solenoid Control Power Consumption

Volts	Amperes		Coil Resistance Ohms
	Holding	Inrush	
AC 60 Hz			
24	2.88	25.4	0.5
120	.575	5.1	14.1
208	.330	2.93	40
240	.288	2.54	58
440	.156	1.38	174
440	.143	1.27	233
Volts (AC 50 Hz)	Amperes		Coil Resistance Ohms
	Holding	Inrush	
110	.48	4.6	15.7
220	.24	2.3	66
240	.22	2.1	88

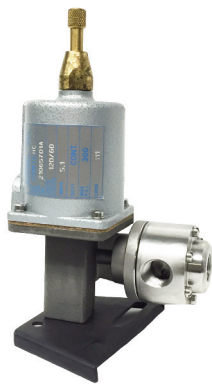

CSM11-HC Specifications

Enclosure General purpose NEMA Type 3; Aluminum
Note: For other enclosures and NEMA Types, consult factory

Housing Body — Aluminum
Trim — Stainless Steel

Operating Pressure: Maximum pressure 300 psi,
for higher pressure consult factory.

Coil Insulation Class A (molded)

AC voltage 15.4 watts

Pilot System Specifications

Temperature Range

Water to 180°F Max

Materials

Standard Pilot System Materials

Pilot Control: Low Lead Bronze

Trim: Stainless Steel Type 303

Rubber: Buna-N® Synthetic Rubber

Optional Pilot System Materials

Pilot Systems are available with optional Aluminum, Stainless Steel or Monel materials.

Wiring Diagram

Auto-Off-Hand	= Selector Switch
1CR	= Relay, DPST Normally Open
2CR	= Relay, DPST Normally Open
3CR	= Relay, TPST Normally Open
SW ₁	= Switch, Remote Start, Automatic
SW ₂	= Switch, SPDT, Valve Limit Switch Connect to N.C. Terminal
PVS	= Pilot Valve Solenoid
M	= Pump Motor Starter

Note: SW₂ and PVS supplied by Cla-Val. All other electrical items supplied by customer. SW₂ is included in the X105L switch assembly which is mounted on the pump control valve cover.

Shown In Pump Off Position

